

WILLIAM GRAY

WILLIAMGRAY.COM @MRWILLIAMGRAY BY MEYER DAVIS



PRODUCT: Varick Single Arm Chair

COLLECTION: VARICK

MANUFACTURER: STELLAR WORKS

CURATED BY:
2020, N.Y.C.

William Gray

WG

© 2023 WILLIAM GRAY INC.

Varick Single Arm Chair

PRODUCT ID WG-S412-L / R (Wood) WG-S413-L / R (Leather)

DESCRIPTION Varick is marked by clean crisp lines and a tailored, contrasting arm that cradles the cushion in either wood or leather. A timeless design, Varick references Mid-Century Modernism with its focus on functional beauty. The Varick Single Arm Chair is an asymmetrical piece, perfect for nestling into with a book or a cocktail. Available in a range of finishes, COM/COL and is customizable upon request. May be specified in a left or right orientation

DIMENSIONS D x W x H x SH
32.3 x 41.7 x 32 x 18.2 in
820 x 1060 x 813 x 462 mm

MATERIAL OPTIONS Available in all Stellar Works finishes, graded in fabrics & leathers.

WOOD
a. Natural Oak
b. Gray Oak
c. Dark Brown Oak
d. Onyx Oak
e. Natural Walnut
f. Soap Walnut



a



b



c



d



e

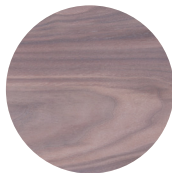

f

Varick Single Arm Chair



Varick Single Arm Chair



Varick Single Arm Chair

Plan

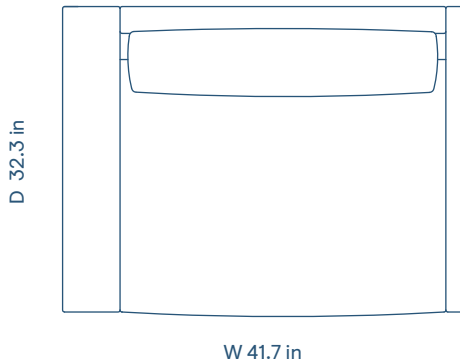

Front Elevation

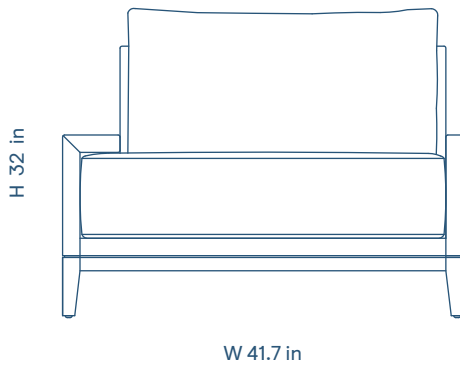

Side Elevation

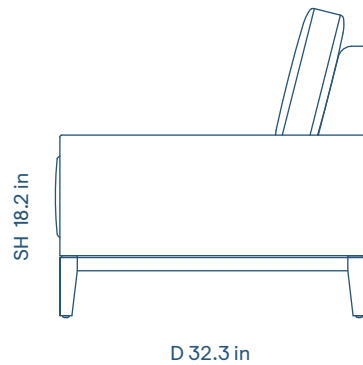

Materials Collection: Leathers

LEATHER SAMPLES A

New Castle
(Aniline Leather)



Black New
65



Charcoal New
1365



Dark Brown New
25



Green New
35

LEATHER SAMPLES B

Crystal
(Aniline Leather)



Baltic
3814



Black
9893



Chestnut
8042



Wolf
3386

Milano
(Pigmented Leather)



Black
2522



Milano Brown
0972



Milano Ivory
5020

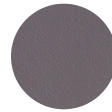

Milano Quartz
2123

LEATHER SAMPLES C

Bellagio
(Pigmented Leather)



Black
7925



Charcoal
4502



Cream
8805



Dark Brown
4501



Quartz
5070

PU LEATHER

Omega
(Surface 100%
Polyurethane,
Base 100% Polyester)



Black



Dark Brown



Grey



Ice

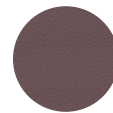

Tabac



Toffee

SADDLE LEATHER



Black



Nude



Brown

Materials Collection: Fabrics

FABRIC SAMPLES C

Cotton
(100% Cotton)



414

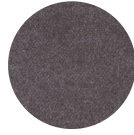

4114

Era
(100% Polyester)



Cse 02



Cse 13



Cse 14



Cse 45

Linen
(100% Linen)



421



422

Manhattan
(100% PES)



600



801



804



805

Revive 1
(100% recycled FR)



164



184



194

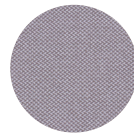

324

Revive 2
(100% recycled polyester FR)

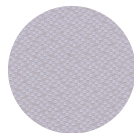

133

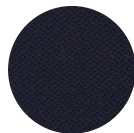

183



193



383

Ruby
(100% PES)



104



617



800



805

Materials Collection: Fabrics

FABRIC SAMPLES A

Divina Melange
(100% New Wool)

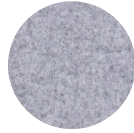

120

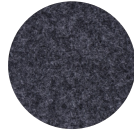

170



180



280

Harald
(100% Cotton)



182



242



283



382

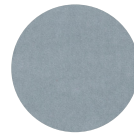

823

Steelcut Trio
(90% New Wool, 10% Nylon)

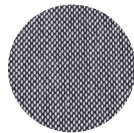

124

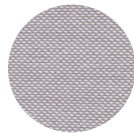

213



383

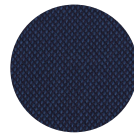

796

FABRIC SAMPLES B

Field
(100% Trevira CS)

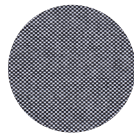

142



182



693



793

Main line flax
(70% virgin wool, 30% flax)



16



20



28

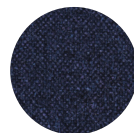

36

Melange Nap

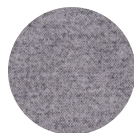

111

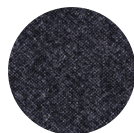

191

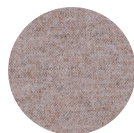

211

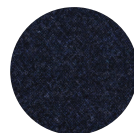

791

Messenger
(70% virgin wool, 30% flax)



Ash 077



Bayou 008



Fossil 076

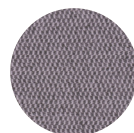

Husk 081