

WILLIAM GRAY

WILLIAMGRAY.COM @MRWILLIAMGRAY BY MEYER DAVIS



PRODUCT: Hugo Bar Stool

COLLECTION: HUGO

MANUFACTURER: STELLAR WORKS

CURATED BY:
2020, N.Y.C.

William Gray

WG

©2023 WILLIAM GRAY INC.

Hugo Bar Stool

PRODUCT ID

WG-S310-750

DESCRIPTION

This modern take on a Campaign Chair has been meticulously detailed for dining. The result is a workhorse piece of furniture with a light and nimble footprint. Hugo highlights both sides of a leather hide, adding a fresh layer of texture. A playful strap marries back to the seat. The Hugo Bar Stool is perfectly scaled for any bar setting, whether inside of a grand restaurant or a residential wet bar. Available in a range of finishes, COM/COL, and customizable upon request, Hugo can sit anywhere.

DIMENSIONS

D × W × H × SH
21.3 × 18 × 41.3 × 29.6 in
542 × 456 × 1049 × 751 mm

MATERIAL OPTIONS

Available in all Stellar Works finishes, graded in fabrics & leathers.

WOOD

- a. Natural Oak
- b. Gray Oak
- c. Dark Brown Oak
- d. Onyx Oak
- e. Natural Walnut
- f. Soap Walnut



a



b



c



d



e



f

Hugo Bar Stool



Hugo Bar Stool



Hugo Bar Stool

Plan

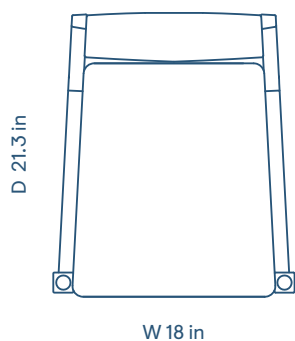

Front Elevation

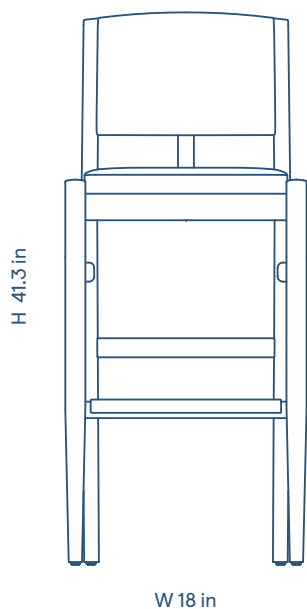

Side Elevation

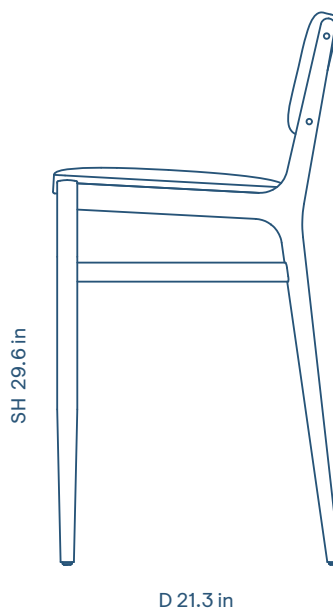

Materials Collection: Leathers

LEATHER SAMPLES A

New Castle
(Aniline Leather)



Black New
65



Charcoal New
1365



Dark Brown New
25



Green New
35

LEATHER SAMPLES B

Crystal
(Aniline Leather)



Baltic
3814



Black
9893



Chestnut
8042



Wolf
3386

Milano
(Pigmented Leather)



Black
2522



Milano Brown
0972



Milano Ivory
5020

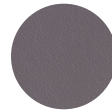

Milano Quartz
2123

LEATHER SAMPLES C

Bellagio
(Pigmented Leather)



Black
7925



Charcoal
4502



Cream
8805



Dark Brown
4501



Quartz
5070

PU LEATHER

Omega
(Surface 100%
Polyurethane,
Base 100% Polyester)



Black



Dark Brown



Grey



Ice

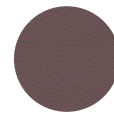

Tabac



Toffee

SADDLE LEATHER



Black



Nude



Brown

Materials Collection: Fabrics

FABRIC SAMPLES C

Cotton
(100% Cotton)



414

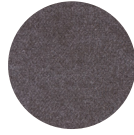

4114

Era
(100% Polyester)



Cse 02



Cse 13



Cse 14



Cse 45

Linen
(100% Linen)



421



422

Manhattan
(100% PES)



600



801

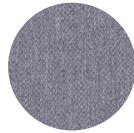

804



805

Revive 1
(100% recycled FR)



164



184



194

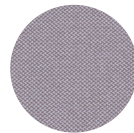

324

Revive 2
(100% recycled polyester FR)

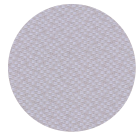

133

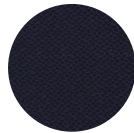

183



193



383

Ruby
(100% PES)



104



617



800



805

Materials Collection: Fabrics

FABRIC SAMPLES A

Divina Melange
(100% New Wool)

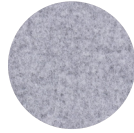

120

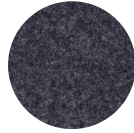

170



180



280

Harald
(100% Cotton)



182



242



283



382

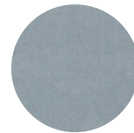

823

Steelcut Trio
(90% New Wool, 10% Nylon)

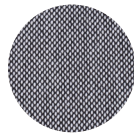

124

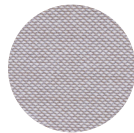

213



383

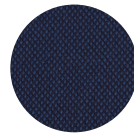

796

FABRIC SAMPLES B

Field
(100% Trevira CS)



142



182



693



793

Main line flax
(70% virgin wool, 30% flax)



16

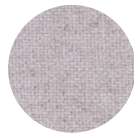

20



28

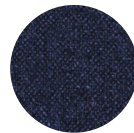

36

Melange Nap

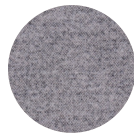

111

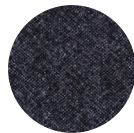

191

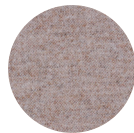

211

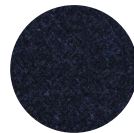

791

Messenger
(70% virgin wool, 30% flax)



Ash 077



Bayou 008



Fossil 076

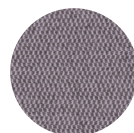

Husk 081